

9.ER.32STD

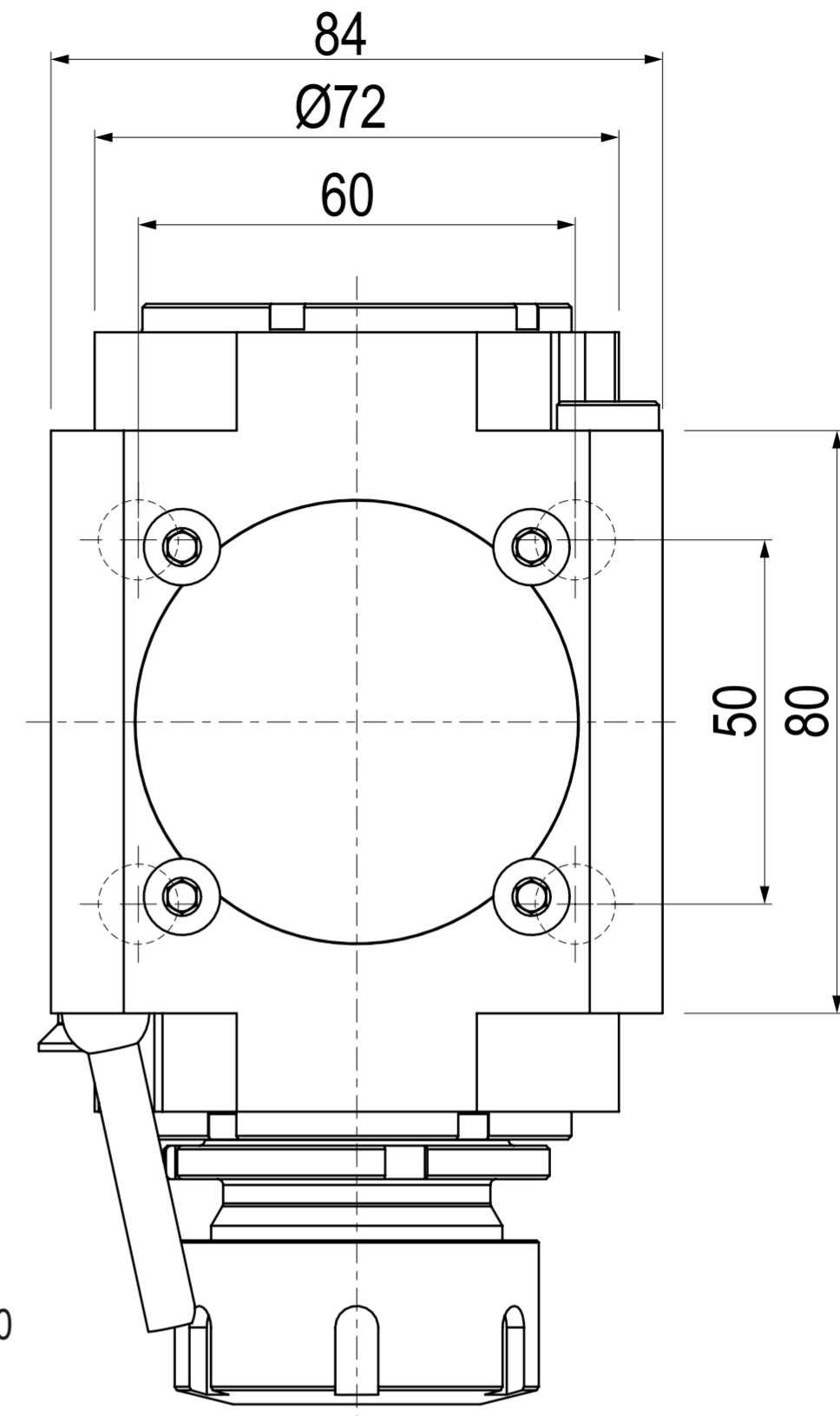

9.RF.12490

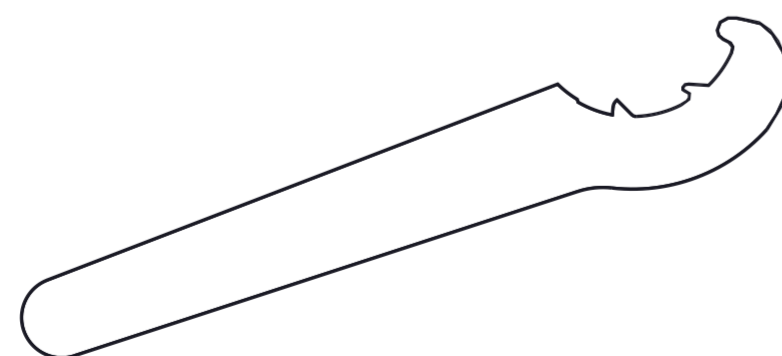

Chiave albero
Shaft wrench

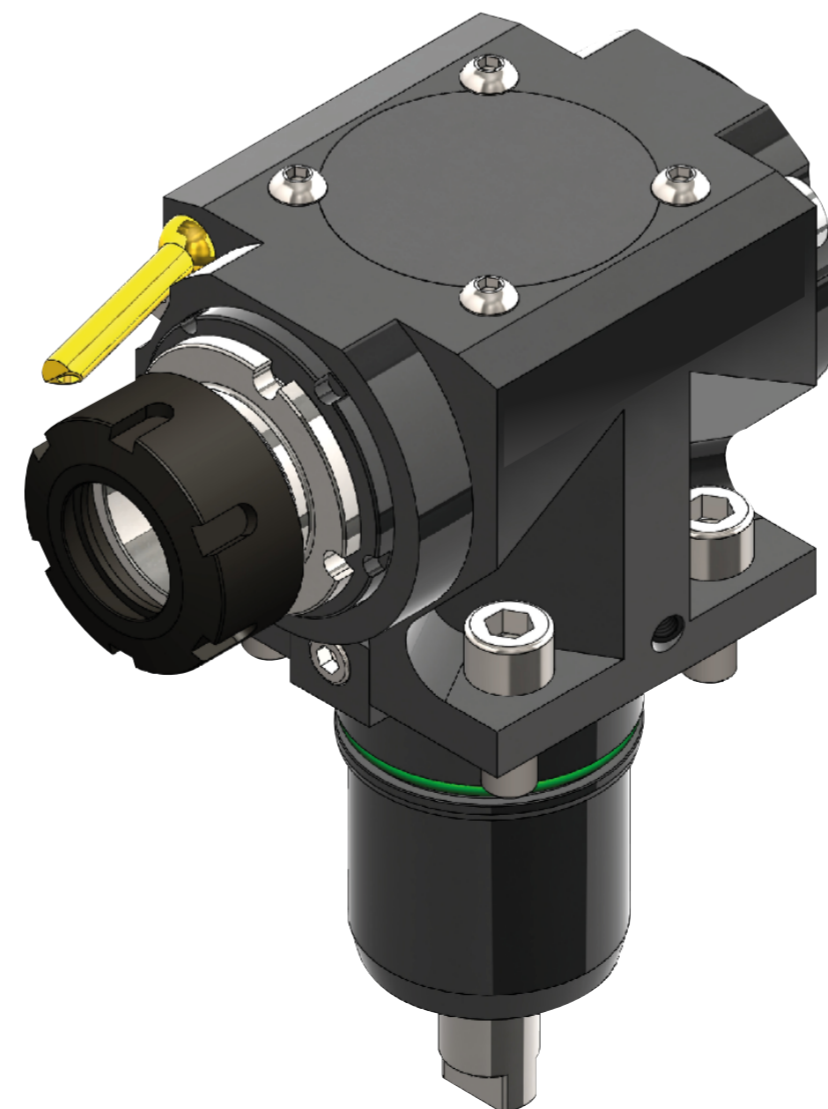

▼ Senso di rotazione contrario al mandrino
Direction of rotation opposite to machine spindle

 GERARDI GERARDI S.P.A. Lonate Pozzolo (VA) Italy Tel. +39-0331-303911 Fax. +39-0331-301534	Motorizzato per torretta Driven tool for turret	NAKAMURA BMT55	
	Denominazione Denomination	Motorizzato Radiale 90° 90° Radial Driven tool	Refr. Esterno External Cool.
Portapinza Collet chuck	Modello Model	Potenza max Max power	Data Date
ER-32 - Ø2±20	RADIAL	10 kw	04/06/2019
N° giri RPM max	Rapp. trasmis. Ratio	Coppia max Max Torque	N° disegno Code
6.000	1:1	63 Nm	99.NK.A15

Questo disegno e' di esclusiva proprietà della GERARDI S.P.A. la quale ne vieta la copia, la riproduzione e la cessione a terzi a norma di legge.
This drawing is of GERARDI S.P.A. exclusive property. The reproduction and use by others is forbidden by law.